

Port Sizes: 1/8 & 1/4 – Flow to 25 scfm

Port Size	Port Threads	Polycarbonate Bowl		Metal Bowl	
		High-Flow	Low Flow	High-Flow	Low Flow
		Model Number	Model Number	Model Number	Model Number
With Fill Port					
1/8	NPTF	5111B1010	5111B1012	5112B1010	5112B1012
	G	C5111B1010	C5111B1012	C5112B1010	C5112B1012
1/4	NPTF	5111B2010	5111B2012	5112B2010	5112B2012
	G	C5111B2010	C5111B2012	C5112B2010	C5112B2012
With Quick-Fill Cap					
1/8	NPTF	C5111B1110	C5111B1112	C5112B1110	C5112B1112
	G	5111B1110	5111B1112	5112B1110	5112B1112
1/4	NPTF	C5111B2110	C5111B2112	C5112B2110	C5112B2112
	G	5111B2110	5111B2112	5112B2110	5112B2112

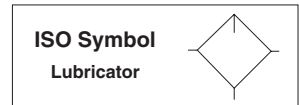

Port Size	Bowl Type	Bowl Capacity	Dimensions inches (mm)				Weight lb (kg)
			A	B	C	Depth	
1/8, 1/4	Polycarbonate	2-oz (60-ml)	1.6 (41)	3.6 (92)	0.7 (17)	1.6 (41)	0.21 (0.10)
1/8, 1/4	Aluminum	2-oz (60-ml)	1.6 (41)	3.8 (97)	0.7 (17)	1.6 (41)	0.21 (0.10)

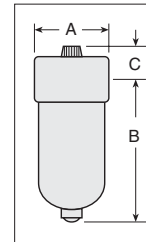

E

E4

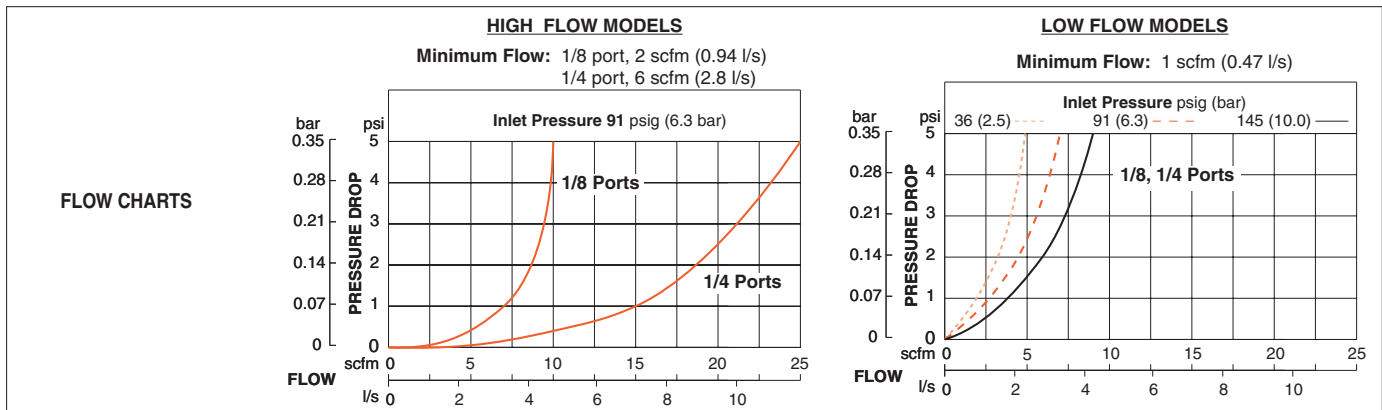

Accessories ordered separately, refer to page E6.3-4.

STANDARD SPECIFICATIONS (for lubricators on this page):

Construction Design	Wick-Feed	Oil Adjustment	Internal, tamper-proof
Temperature	Ambient/Media: Polycarbonate Bowl: 40° to 125°F (4° to 52°C) Metal Bowl: 40° to 150°F (4° to 66°C)	Construction Material	Body: Aluminum Bowl: Polycarbonate or Aluminum Seals: Nitrile
Fluid Media	Compressed air		
Operating Pressure	Polycarbonate Bowl: Maximum 150 psig (10 bar) Metal Bowl: Maximum 200 psig (14 bar)		

IMPORTANT NOTE: Please read carefully and thoroughly all of the **CAUTIONS, WARNINGS** on the inside back cover.

Mounting Screws for BANTAM Models

Usage Models	Kit Number
BANTAM	859K77

BANTAM models mounts with long screws that extend through end plates.

Mounting Brackets for Regulators and Integrated Filter/Regulators

Regulators and integrated filter/regulators can be mounted to a surface with a bracket that attaches to the regulator. Brackets and mounting panel nuts can be ordered separately or in a kit which includes both bracket and mounting panel nut.

Usage Models	Model Number			Dimensions inches (mm)					Panel Mounting Hole Diameter
	Kit	Bracket	Panel Nut	A	B	C	D	E	
MINIATURE	873K77	872K77	874K77	1.375 (35)	1.125 (29)	0.31 (8)	0.31 (8)	0.69 (17)	1.19 (30)
MID-SIZE	876K77	875K77	877K77	2.38 (60)	1.00 (25)	1.50 (38)	–	–	1.56 (40)
MD3™	R-A127-11	–	R-127-11	2.38 (60)	1.00 (25)	1.50 (38)	–	–	2.06 (52)
FULL-SIZE, MD4™	879K77	878K77	880K77	2.38 (60)	1.00 (25)	1.50 (38)	–	–	2.06 (52)

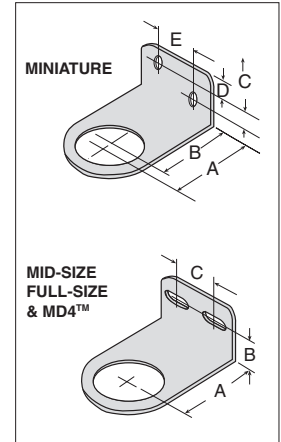

Modular Mounting Brackets for Filters, Regulators, Lubricators, FRL's, or Clean Air Packages

Two L-shaped metal brackets as shown at the right can be used for wall mounting of modular FRLs or Clean Air Packages. A single bracket can be used to mount individual filters or lubricators. Kits include two brackets and four screws for attaching the brackets to the modules.

Usage Models	Kit Number	Dimensions inches (mm)			
		A	B	C	D
MID-SIZE & FULL-SIZE	915K77	3.0 (76)	0.88 (22)	1.00 (25)	1.20 (31)

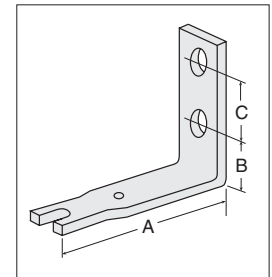

FRLs In-line Mounting Pipe Brackets

Two pipe brackets can be used for wall mounting of FRLs assemblies that use pipe nipples to join the components. The bracket kits listed below include two sets of brackets.

Nipple Size	Kit Number	Dimensions inches (mm)		
		A	B	C
1/4	887K77	2.72 (28)	0.50 (13)	1.00 (25)
3/8	888K77	2.72 (28)	0.50 (13)	1.00 (25)
1/2	889K77	2.72 (28)	0.50 (13)	1.00 (25)
3/4	890K77	3.69 (94)	1.13 (29)	1.25 (32)
1	891K77	3.69 (94)	1.13 (29)	1.25 (32)

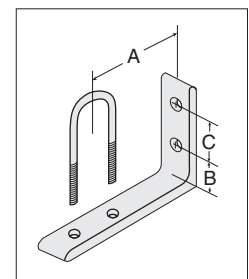

Bracket Assembly Kit for HIGH-RELIEF Pilot Operated Regulator

High-Relief Pilot Operated Regulator with 1/4- thru 1 1/4 inch ports can be mounted to a vertical surface using a bracket assembly kit.

Kit Number
R-A37-381

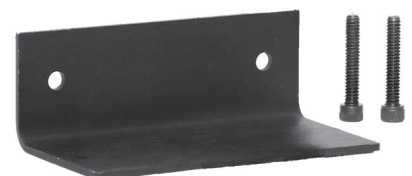

IMPORTANT NOTE: Please read carefully and thoroughly all of the **CAUTIONS, WARNINGS** on the inside back cover.

MID-SIZE and FULL-SIZE Units

The modular designs of the MID-SIZE and FULL-SIZE series offer maximum flexibility in customizing FRLs assemblies. As shown at the right, connector kits are required to interconnect units. Various port kits (shown below) can be used to connect the assemblies to the inlet and outlet piping. Note that all FRLs components have threaded ports so that conventional pipe fittings may be used where desired.

Female Port Block

Used to connect to piping at inlet or outlet.

Port Size	Model Number	
	NPTF Threads	G Threads
1/4	897K77	D897K77
3/8	898K77	D898K77
1/2	899K77	D899K77
3/4	900K77	D900K77



Male Port Block

Used to connect modular to non-modular units.

Port Size	Model Number	
	NPTF Threads	G Threads
1/4	893K77	D893K77
3/8	894K77	D894K77
1/2	895K77	D895K77
3/4	896K77	D896K77



Connector Kit

Used to connect units to one another as well as to any of the ports shown on this page.

Kit Number	892K77
------------	--------

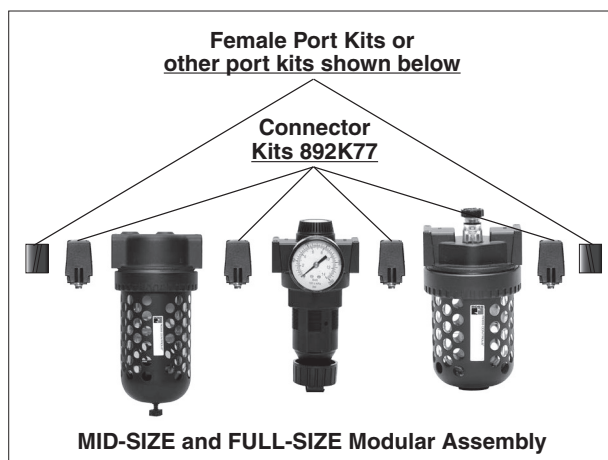

E

BANTAM Units

BANTAM modular units use end plates secured with screws to hold the pipe or tubing ports (see below), and also to serve as mounting brackets. Short screws are used to secure the end plates when a single BANTAM unit is used. If two or more units are combined, long screws extend through an end plate and thread into the next unit.

Screw kits required are as follows:

Single Unit: Two short screw kits.

Two-Unit Combination: One each short screw kit and long screw kit.

Three-Unit Combination: Two long screw kits.

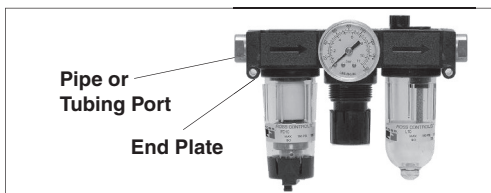

Pipe Ports	
Port Size	Model Number
1/8 NPTF	862K77
1/4 NPTF	863K77
1/8 BSPP	D864K77
1/4 BSPP	D865K77

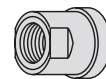

E6

Pipe Ports	
Kit Description	Model Number
END PLATE (1)	857K77
Short Screw (2)	858K77
Long Screw (2)	859K77
Small O-Ring (for inlet or mating ports)	860K77
Large O-Ring (for outlet or mating ports)	861K77

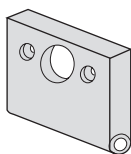

Tube Ports	
Port Size	Model Number
1/4	866K77
3/8	867K77
4 mm	868K77
6 mm	869K77
8 mm	870K77
10 mm	871K77

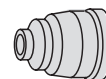

IMPORTANT NOTE: Please read carefully and thoroughly all of the **CAUTIONS, WARNINGS** on the inside back cover.

Modular Assemblies

Accessories: Clamp, Brackets, End Ports & Port Blocks

MD Series

Dimensions: inches (mm)

MD3™ Series

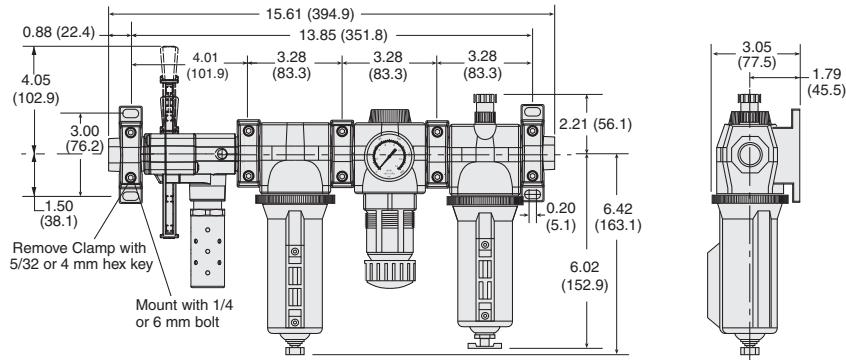

MD4™ Series

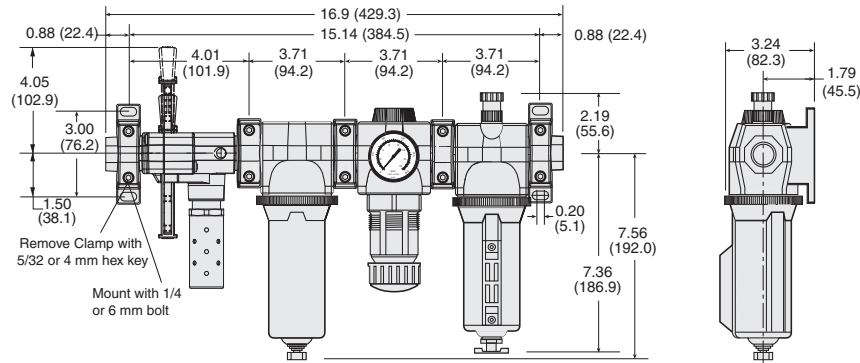

Mounting Brackets & Clamp for Module Connections

Two brackets are normally used to mount an FRL to a vertical surface. The mounting bracket attaches to the module connecting clamp (see above) with a single screw. Each bracket then employs two bolts (1/4" or 6mm) to connect the assembly to the mounting surface. Specially designed clamps provide a quick and easy assembly or disassembly of MD3™ modules. Two Allen-Head bolts quickly tighten or loosen the clamp using a 5/32 or 4mm hex key. The clamp contains a plate carrying two O-rings to provide positive sealing between modules.



Bracket, Screw, and Clamp



Module Connecting Clamp



Mounting Bracket

Mounting Brackets & Clamp for Module Connections

Description	Model Number
Bracket and Screw	R-A118-103
Module Connecting Clamp	R-A118-105
Bracket, Screw, and Clamp	R-A118-105M

Male and Female End Ports

Either male or female end ports can be attached to threaded inlet and outlet lines. This allows all modules of an FRL assembly to be removed easily and quickly without having to unthread the end modules. The end ports are attached to the modules with clamps (see at left). End ports can be included in an assembled FRL or ordered separately by the following model numbers:

Type	Port Size	Model Number		
		NPTF Threads	G Threads	
Female	1/4	R-118-100-2	R-118-100-2W	
	3/8	R-118-100-3	R-118-100-3W	
	1/2	R-118-100-4	R-118-100-4W	
	3/4	R-118-100-6	R-118-100-6W	
Male	1/4	R-118-109-2F	R-118-109-2FW	
	3/8	R-118-109-3F	R-118-109-3FW	
	1/2	R-118-109-4F	R-118-109-4FW	
	3/4	R-118-109-6F	R-118-109-6FW	

Extra Port Blocks

An extra port block can be placed between modules to provide two auxiliary 1/4 NPTF ports. Its mounting position can be rotated to obtain the most convenient operating orientation. If only one auxiliary port is to be used, the unused port must be closed with a pipe plug. (The inlet and outlet are not threaded.)

Port Size	Model Number	
	NPTF Threads	G Threads
1/4	R-118-106-2	R-118-106-2W
3/8	R-118-106-3	R-118-106-3W
1/2	R-118-106-4	R-118-106-4W



IMPORTANT NOTE: Please read carefully and thoroughly all of the **CAUTIONS, WARNINGS** on the inside back cover.



Online Version
04/05/19

rosscontrols.com

Analog Pressure Gauges

Pressure Gauges (Center Back Mounting)	Type/Material	Port Size	Model Number		Pressure Range psig (bar)	Case Diameter inches (mm)
			Thread			
			NPT	G		
Standard Aluminum		1/8	5400A1002	D5400A1002	0-160 (0-11)	1.7 (43)
		1/4	5400A2010	D5400A2010	0-60 (0-4)	2.0 (51)
		1/4	5400A2011	D5400A2011	0-200 (0-14)	2.0 (51)
		1/4	5400A2012	D5400A2012	0-300 (0-20)	2.0 (51)
Liquid Filled Stainless Steel		1/4	5400A2014	D5400A2014	0-160 (0-11)	2.5 (64)
		1/4	5400A2015*	D5400A2015*	0-160 (0-11)	2.0 (51)

*Green shade between 40-70 psi (2.7-4.8 bar).

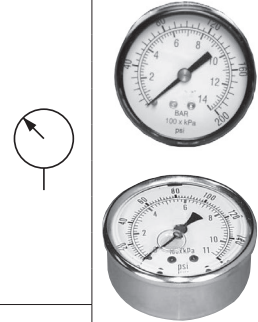

Differential Pressure Gauges

DIFFERENTIAL PRESSURE GAUGE TYPE/SERIES	Small Slide Gauge	Small Slide Gauge	Large Dual Face Gauge	Large Dual Face Gauge with Reed Switch (Normally Open)	Large Dual Face Gauge with Reed Switch (Normally Closed)
	R-A60F-28	R-K103-151	R-106-35	R-106-35E	R-106-35EC
FILTERS					
BANTAM	-	-	-	-	-
MINIATURE	-	-	-	-	-
MID-SIZE	-	-	-	-	-
MD3™		-	-	-	-
FULL-SIZE	-	-	-	-	-
MD4™	-				
HIGH-CAPACITY	-	-	-	-	-
COALESCING FILTERS					
BANTAM	-	-	-	-	-
MINIATURE	-	-	-	-	-
MID-SIZE		-	-	-	-
FULL-SIZE	-				
MD3™		-	-	-	-
MD4™	-				
HIGH-CAPACITY	-				
OIL VAPOR REMOVAL (ADSORBING) FILTERS					
MD3™	-	-	-	-	-
MD4™	-	-	-	-	-
CLEAN AIR PACKAGES					
MD3™		-	-	-	-
MD4™	-				

IMPORTANT NOTE: Please read carefully and thoroughly all of the **CAUTIONS, WARNINGS** on the inside back cover.

E

E6

External Automatic Drains

Pipe Size	Model Number*	
	Polycarbonate Bowl**	Metal Bowl
1/8	5057B1001	5058B1001
1/4*	5057B2001	5058B2001

*Use 1/4 size with FULL-SIZE, HIGH-CAPACITY, MD3™ & MD4™ filters.
Use kit 1076K77 to convert standard bowl to accept auto drain unit.
**Available for FULL-SIZE filters only. Polycarbonate bowl includes metal bowl guard.

Port Size	Dimensions inches (mm)			Weight lb (kg)
	A	B	C	
1/8, 1/4	3.5 (89)	4.2 (107)	8.3 (211)	2.6 (1.2)

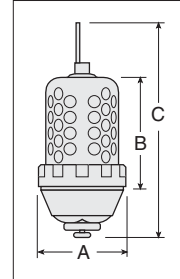

Electronically Controlled Drain

Pipe Size	Voltage	Model Number	
		NPTF Threads	G Threads
1/4	24 volts DC	R-DED-24V-2	R-DED-24V-2W
3/8	24 volts DC	R-DED-24V-3	R-DED-24V-3W
1/2	24 volts DC	R-DED-24V-4	R-DED-24V-4W
1/4	110-120 volts AC, 50/60 Hz	R-DED-115V-2	R-DED-115V-2W
3/8	110-120 volts AC, 50/60 Hz	R-DED-115V-3	R-DED-115V-3W
1/2	110-120 volts AC, 50/60 Hz	R-DED-115V-4	R-DED-115V-4W

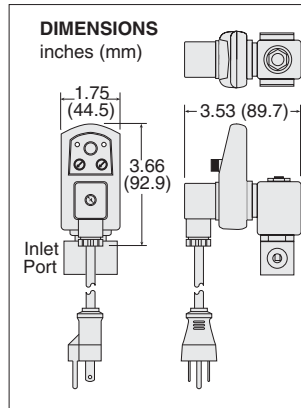

E

STANDARD SPECIFICATIONS (for electronically controlled drain):

Drain Time	Adjustable 0.5 to 10 seconds	Electrical Connection	DIN 43650A, ISO 440/6952
Drain Interval	0.5 to 45 minutes	Valve Type	2/2 direct acting, normally closed
Current Consumption	Maximum 4 ma	Valve Body	Forged brass; 3/16-inch (4.8 mm) orifice
Temperature	Ambient: 35° to 130°F (2° to 54°C)	Maximum Pressure	230 psig (15.8 bar)
	Media: 35° to 190°F (2° to 88°C)		

Silencers

Port Size	Thread Type	Model Number*		Avg. C _v	Dimensions inches (mm)		Weight lb (kg)
		NPT Threads	R Threads		Width	Length	
3/8	Male	5500A3003	D5500A3003	4.3	1.3 (32)	3.5 (88)	0.2 (0.1)
3/4	Male	5500A5013	D5500A5013	5.1	1.3 (32)	3.6 (92)	0.2 (0.1)
3/4	Male	5500A5003	D5500A5003	11.5	2.0 (51)	5.3 (135)	0.6 (0.3)

Flow Media: Filtered air.
Pressure Range: 0 to 290 psig (0 to 20 bar) maximum.



E6

IMPORTANT NOTE: Please read carefully and thoroughly all of the **CAUTIONS, WARNINGS** on the inside back cover.

Category	Series	Bowl Type	Element Rating	Element Material	Model Number
Filters	Bantam & Miniature	Standard	5-µm	Polyethylene	933K77
			5-µm	Sintered Bronze	R-KA130-27E5
			20-µm	Sintered Bronze	R-KA130-27E4
			40-µm	Sintered Bronze	R-KA130-27E3
	MID-SIZE	Standard	5-µm	Polyethylene	936K77
	MD3™	Standard	5-µm	Polyethylene	R-A60F-03PE5
			5-µm	Sintered Bronze	R-A60F-03E5
			20-µm	Sintered Bronze	R-A60F-03E4
			40-µm	Sintered Bronze	R-A60F-03E3
	FULL-SIZE	Standard	5-µm	Polyethylene	939K77
			5-µm	Sintered Bronze	R-KA103-03E5
			20-µm	Sintered Bronze	R-KA103-03E4
			40-µm	Sintered Bronze	R-KA103-03E3
	MD4™	Standard	5-µm	Polyethylene	R-A115-106PE5
			5-µm	Sintered Bronze	R-A115-106E5
			20-µm	Sintered Bronze	R-A115-106E4
			40-µm	Polyethylene	R-A115-106PE3
	HIGH-CAPACITY Flow to 275 scfm	Standard	5-µm	Polyethylene	1010K77
			5-µm	Sintered Bronze	R-KA109-03E5
			20-µm	Sintered Bronze	R-KA109-03E4
40-µm			Sintered Bronze	R-KA109-03E3	
HIGH-CAPACITY Flow to 660 scfm	Standard	5-µm	Sintered Bronze	1656K77	
		40-µm	Sintered Bronze	R-A114-106E3	
HIGH-CAPACITY Flow to 1000 scfm	Standard	5-µm	Sintered Bronze	942K77	
		40-µm	Sintered Bronze	944K77	
Coalescing Filters	Bantam & Miniature	Standard	0.3-µm	Borosilicate-glass-fiber	945K77
			0.01-µm	Borosilicate-glass-fiber	R-A-10F-16E8
	MID-SIZE	Standard	0.3-µm	Borosilicate-glass-fiber	R-A60F-29
			0.3-µm	Borosilicate-glass-fiber	R-A60F-32
		Extended	0.01-µm	Borosilicate-glass-fiber	R-A60F-29E8
			0.01-µm	Borosilicate-glass-fiber	R-A60F-32E8
	MD3™	Polycarbonate	0.3-µm	Borosilicate-glass-fiber	R-A60F-23
		Metal	0.3-µm	Borosilicate-glass-fiber	R-A60F-29
		Extended Metal	0.3-µm	Borosilicate-glass-fiber	R-A60F-32
		Polycarbonate	0.01-µm	Borosilicate-glass-fiber	R-A60F-23E8
		Metal	0.01-µm	Borosilicate-glass-fiber	R-A60F-29E8
		Extended Metal	0.01-µm	Borosilicate-glass-fiber	R-A60F-32E8
	FULL-SIZE	Standard	0.3-µm	Borosilicate-glass-fiber	947K77
			0.3-µm	Borosilicate-glass-fiber	R-A103-160L
		Extended	0.01-µm	Borosilicate-glass-fiber	948K77
			0.01-µm	Borosilicate-glass-fiber	R-A103-160LE8
	MD4™	Standard	0.3-µm	Borosilicate-glass-fiber	R-A115-117
			0.3-µm	Borosilicate-glass-fiber	R-A115-118
		Extended	0.01-µm	Borosilicate-glass-fiber	R-A115-117E8
			0.01-µm	Borosilicate-glass-fiber	R-A115-118E8
	HIGH-CAPACITY Flow to 220 scfm	Standard	0.3-µm	Borosilicate-glass-fiber	949K77
			0.01-µm	Borosilicate-glass-fiber	R-A109-106E8
	HIGH-CAPACITY Flow to 295 & 450 scfm	Standard	0.3-µm	Borosilicate-glass-fiber	R-A114-112
			0.3-µm	Borosilicate-glass-fiber	R-A114-113
		Extended	0.01-µm	Borosilicate-glass-fiber	R-A114-112E8
			0.01-µm	Borosilicate-glass-fiber	R-A114-113E8
	HIGH-CAPACITY Flow to 465 scfm	Standard	0.3-µm	Borosilicate-glass-fiber	952K77
			0.3-µm	Borosilicate-glass-fiber	953K77
		Extended	0.01-µm	Borosilicate-glass-fiber	R-A106-24E8
			0.01-µm	Borosilicate-glass-fiber	R-A106-24LE8
HIGH-CAPACITY Flow to 840 scfm	Extended	0.3-µm	Borosilicate-glass-fiber	953K77	
		0.01-µm	Borosilicate-glass-fiber	R-A106-24E8	
Oil Vapor Removal Filters	MD3™	Standard	–	Borosilicate-glass-fiber	R-A60F-29E9
		Extended	–	Borosilicate-glass-fiber	R-A60F-32E9
	MD4™	Standard	–	Borosilicate-glass-fiber	R-A115-117E9
		Extended	–	Borosilicate-glass-fiber	R-A115-118E9
Silencers Reclassifiers	Port Size 1/2	Standard	20-µm	Sintered Bronze	940K77
	Port Size 3/4, 1		100-µm	Sintered Bronze	981K77

E

Lubricants, Polycarbonate Bowl Cautions

Compatible Lubricants

Although air line lubrication is not required for most ROSS valves, other mechanisms in the system may need such lubrication. When a lubricator is used, it should be supplied only with oils which are compatible with the materials used in the valves for seals and poppets. Generally speaking, these are petroleum base oils with oxidation inhibitors, and aniline point between 180°F (82°C) and 220°F (104°C) and an ISO 32, or lighter, viscosity. Oils with phosphate type additives, such as zinc dithiophosphate, must be avoided because they can harm polyurethane valve components. The best oils to use in pneumatic systems are those specifically compounded for air line lubricator service.

Cautions on the Use of Polycarbonate Bowls

Use Only with Compressed Air. Filters and lubricators with polycarbonate bowls are specifically designed for compressed air service, and their use with any other fluid (liquid or gas) is a misapplication. The use with or injection of certain hazardous fluids in the system (e.g., alcohol or liquefied petroleum gas) could be harmful to the polycarbonate bowl or result in a combustible condition or hazardous leakage. Before using with a fluid other than air, or for nonindustrial applications, or for life support systems, consult ROSS.

Use Metal Bowl Guard When Supplied. A metal bowl guard is supplied with all but the smallest bowls, and must always be used to minimize danger from fragmentation in the event of failure of a polycarbonate bowl.

Avoid Harmful Substances. Some compressor oils, chemical cleaners, solvents, paints, and fumes will attack polycarbonate bowls and can cause bowl failure. Do not use with or near these materials. When a bowl becomes dirty, replace the bowl or wipe it with a clean dry cloth. Immediately replace any polycarbonate bowl which is crazed, cracked, or deteriorated.

Substances HARMFUL to Polycarbonate Bowls

Acetaldehyde	Carbon disulfide	Ethylene dichloride	Phosphorous trichloride
Acetic acid	Carbon tetrachloride	Ethylene glycol	Propionic acid
Acetone	Caustic potash solution	Formic acid	Pyridine
Acrylonitrile	Caustic soda solution	Freon (refrigerant & propellant)	Sodium hydroxide
Ammonia	Chlorobenzene	Gasoline (high aromatic)	Sodium sulfide
Ammonium fluoride	Chloroform	Hydrazine	Styrene
Ammonium hydroxide	Cresol	Hydrochloric acid	Sulfuric acid
Ammonium sulfide	Cyclohexanol	Lacquer thinner	Sulfural chloride
Anaerobic adhesives & sealants	Cyclohexanone	Methyl alcohol	Tetrahydronaphthalene
Antifreeze	Cyclohexene	Methylene chloride	Thiophene
Benzene	Dimethyl formamide	Methylene salicylate	Toluene
Benzoic acid	Dioxane	Milk of lime (CaOH)	Turpentine
Benzyl alcohol	Ethane tetrachloride	Nitric acid	Xylene
Brake fluids	Ethyl acetate	Nitrobenzene	Perchlorethylene
Bromobenzene	Ethyl ether	Nitrocellulose lacquer	
Butyric acid	Ethylamine	Phenol	
Carbolic acid	Ethylene chlorohydrin	Phosphorous hydroxyl chloride	

Trade Names of Substances HARMFUL to Polycarbonate Bowls

- Atlas Perma-Guard • Buna N • Cellulube #150 & #220 • Crylex #5 cement • Eastman 910 • Garlock 98403 (polyurethane)
- Haskel 568-023 • Hilgard Company's hil phene • Houghton & Co. oil 1120, 1130, 1055 • Houtosafe 1000 • Kano Kroil
- Keystone penetrating oil #2 • Loctite 271, 290, 601 • Loctite Teflon sealant • Marvel Mystery Oil • Minn. Rubber 366Y
- National Compound N11 • Nylock VC-3 • Parco 1306 Neoprene • Permabond 910 • Petron PD287 • Prestone • Pydraul AC
- Sears Regular Motor Oil • Sinclair oil "Lily White" • Stauffer Chemical FYRQUEL 150 • Stillman SR 269-75 (polyurethane)
- Stillman SR 513-70 (neoprene) • Tannergas • Telar • Tenneco anderol 495 & 500 oils • Titon • Vibra-tite • Zerex



CAUTIONS, WARNINGS and STANDARD WARRANTY

PRE-INSTALLATION or SERVICE

1. Before servicing a valve or other pneumatic component, be sure that all sources of energy are turned off, the entire pneumatic system is shut off and exhausted, and all power sources are locked out (ref: OSHA 1910.147, EN 1037).
2. All ROSS products, including service kits and parts, should be installed and/or serviced only by persons having training and experience with pneumatic equipment. Because any installation can be tampered with or need servicing after installation, persons responsible for the safety of others or the care of equipment must check every installation on a regular basis and perform all necessary maintenance.
3. All applicable instructions should be read and complied with before using any fluid power system in order to prevent harm to persons or equipment. In addition, overhauled or serviced valves must be functionally tested prior to installation and use. If you have any questions, call your nearest ROSS location listed on the cover of this document.
4. Each ROSS product should be used within its specification limits. In addition, use only ROSS parts to repair ROSS products.

WARNING: *Failure to follow these directions can adversely affect the performance of the product or result in the potential for human injury or damage to property.*

FILTRATION and LUBRICATION

5. Dirt, scale, moisture, etc. are present in virtually every air system. Although some valves are more tolerant of these contaminants than others, best performance will be realized if a filter is installed to clean the air supply, thus preventing contaminants from interfering with the proper performance of the equipment. ROSS recommends a filter with a 5-micron rating for normal applications.
6. All standard ROSS filters and lubricators with polycarbonate plastic bowls are designed for compressed air applications only. Do *not* fail to use the metal bowl guard, where provided, to minimize danger from high pressure fragmentation in the event of bowl failure. Do not expose these products to certain fluids, such as alcohol or liquefied petroleum gas, as they can cause bowls to rupture, creating a combustible condition, hazardous leakage, and the potential for human injury or damage to property. Immediately replace a crazed, cracked, or deteriorated bowl. When bowl gets dirty, replace it or wipe it with a clean dry cloth.

7. Only use lubricants which are compatible with materials used in the valves and other components in the system. Normally, compatible lubricants are petroleum based oils with oxidation inhibitors, an aniline point between 180°F (82°C) and 220°F (104°C), and an ISO 32, or lighter, viscosity. Avoid oils with phosphate type additives which can harm polyurethane components, potentially leading to valve failure which risks human injury, and/or damage to property.

AVOID INTAKE/EXHAUST RESTRICTION

8. Do not restrict the air flow in the supply line. To do so could reduce the pressure of the supply air below the minimum requirements for the valve and thereby cause erratic action.
9. Do not restrict a valve's exhaust port as this can adversely affect its operation. Exhaust silencers must be resistant to clogging and must have flow capacities at least as great as the exhaust capacities of the valves. Contamination of the silencer can result in reduced flow and increased back pressure.

WARNING: *ROSS expressly disclaims all warranties and responsibility for any unsatisfactory performance or injuries caused by the use of the wrong type, wrong size, or an inadequately maintained silencer installed with a ROSS product.*

POWER PRESSES

10. Mechanical power presses and other potentially hazardous machinery using a pneumatically controlled clutch and brake mechanism must use a press control double valve with a monitoring device. A double valve without a self-contained monitoring device should be used only in conjunction with a control system which assures monitoring of the valve. All double valve installations involving hazardous applications should incorporate a monitoring system which inhibits further operation of the valve and machine in the event of a failure within the valve mechanism.

ENERGY ISOLATION/EMERGENCY STOP

11. Per specifications and regulations, ROSS L-O-X® and L-O-X® with EEZ-ON® operation products are defined as energy isolation devices, NOT AS EMERGENCY STOP DEVICES.

STANDARD WARRANTY

limited to repair or replacement of the product or refund of the purchase price paid solely at the discretion of ROSS and provided such product is returned to ROSS freight prepaid and upon examination by ROSS is found to be defective. This warranty becomes void in the event that product has been subject to misuse, misapplication, improper maintenance, modification or tampering.

THE WARRANTY EXPRESSED ABOVE IS IN LIEU OF AND EXCLUSIVE OF ALL OTHER WARRANTIES AND ROSS EXPRESSLY DISCLAIMS ALL OTHER WARRANTIES EITHER EXPRESSED OR IMPLIED WITH RESPECT TO MERCHANTABILITY OR FITNESS FOR A PARTICULAR PURPOSE. ROSS MAKES NO WARRANTY WITH RESPECT TO ITS PRODUCTS MEETING THE PROVISIONS OF ANY GOVERNMENTAL OCCUPATIONAL SAFETY AND/OR HEALTH LAWS OR REGULATIONS. IN NO EVENT IS ROSS LIABLE TO PURCHASER, USER, THEIR EMPLOYEES OR OTHERS FOR INCIDENTAL OR CONSEQUENTIAL DAMAGES WHICH MAY RESULT FROM A BREACH OF THE WARRANTY DESCRIBED ABOVE OR THE USE OR MISUSE OF THE PRODUCTS. NO STATEMENT OF ANY REPRESENTATIVE OR EMPLOYEE OF ROSS MAY EXTEND THE LIABILITY OF ROSS AS SET FORTH HEREIN.

All products sold by ROSS CONTROLS are warranted for a one-year period [with the exception of all Filters, Regulators and Lubricators ("FRLs") which are warranted for a period of seven years] from the date of purchase to be free of defects in material and workmanship. ROSS' obligation under this warranty is

